

The accessories

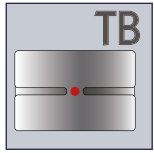

The MicroPress® rack and pinion press is particularly suitable for precise fitting work in light engineering, where the force needed is low but where the operator wants to work sensitively.

The advantages:

- ▶ Press table with T-slot as standard in scope of supply
- ▶ Alternatively, press tables with table bore TB or in flat version or to customer specification can be supplied.
- ▶ Quickly and easily converted from right-handed to left-handed operation.
- ▶ Adjustable daylight
- ▶ Precise guidance of ram
- ▶ Cushioned return stroke
- ▶ Stroke length adjustable
- ▶ Hand lever adjustable over 360°
- ▶ Lightweight design



Rack and pinion press
MPZ 500-30

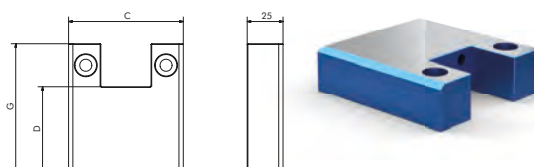
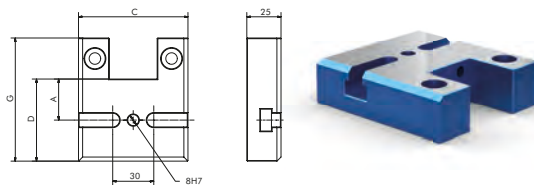
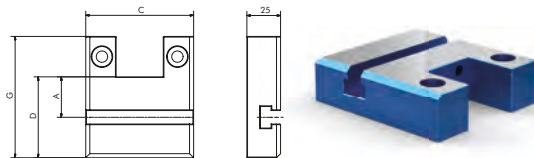
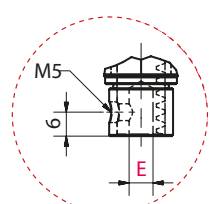
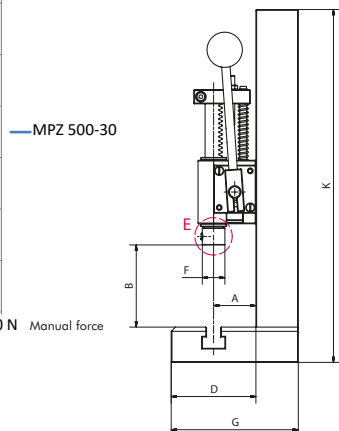
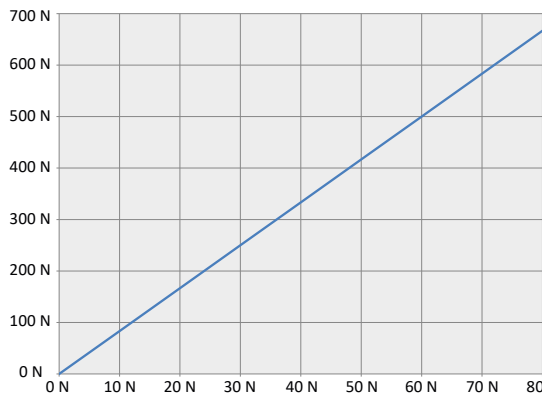

| Type | | | MPZ 500-30 |
|---|-----|----|------------|
| Capacity | | N | 500 |
| Working stroke | | mm | 25 |
| Throat | A | mm | 30 |
| Daylight | B | mm | 25 - 150 |
| Table size | CxD | mm | 80 x 60 |
| T-slot width similar to DIN 650 | E | mm | 6H7 x 12 |
| Ram Ø | F | mm | 16 |
| Space requirement | CxG | mm | 80 x 90 |
| Stand height | | mm | 250 |
| Weight | | kg | ca. 1.5 |
| Tabletop | | | |
| Table 1 T-slot width similar to DIN 650 | | mm | 10 |
| Table 2 T-slot with TB | | mm | 8H7 |
| Table 3 plan | | | |

*Not included. Accessories must be ordered separately.

Request CAD at www.maederpressen.de or directly from Tel. +49 (0)7467-9467-0