

DA Series with round ram
L-DA Series with round ram, daylight 350 mm

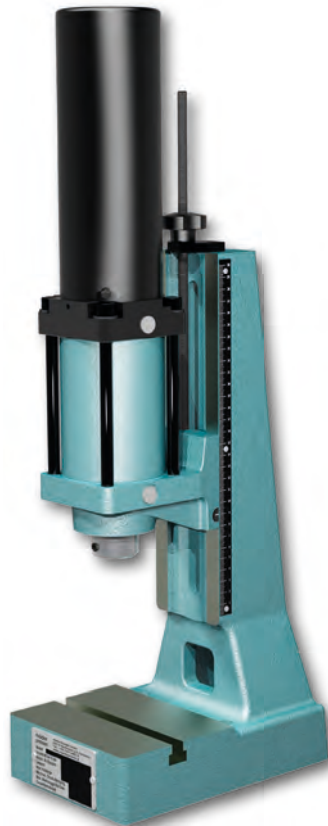

DA 150-80-63



DA 250-80-80

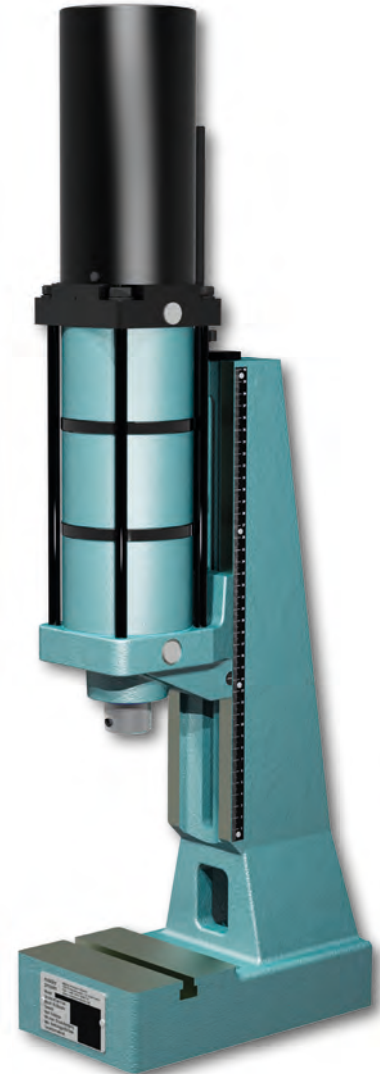

L-DA 1300-40-80

Type			DA 150-80-63	DA 250-80-80	L-DA 250-80-80	DA 450-*-80	L-DA 450-*-80	DA 850-*-80	L-DA 850-*-80	L-DA 1300-*-80
Capacity at 6 bar		kN	1.5	2.5	2.5	4.5	4.5	8.5	8.5	13
Working stroke max.*		mm	80	80	80	40/60/80/ 100/120	40/60/80/ 100/120	40/60/80/ 100/120	40/60/80/ 100/120	40/60/80/ 100/120
Throat	A	mm	63	80	80	80	80	80	80	80
Daylight	B	mm	40 - 215	70 - 280	65 - 390	58 - 243	65 - 350	58 - 243	65 - 350	65 - 350
Table size	CxD	mm	100 x 65	157 x 115	157 x 115	157 x 115	157 x 115	157 x 115	157 x 115	157 x 115
T-slot width similar to DIN 650		mm	10	12	12	12	12	12	12	12
Ram bore Ø x Depth	E	mm	16H7 x 25	20H7 x 25	20H7 x 25	20H7 x 25	20H7 x 25	20H7 x 25	20H7 x 25	20H7 x 25
Ram Ø	F	mm	30	40	40	40	40	40	40	40
Air connection			G 1/4"	G 1/4"	G 1/4"	G 3/8"	G 3/8"	G 3/8"	G 3/8"	G 3/8"
Air consumption/cm cyl. stroke		l	0.2	0.3	0.3	1.0	1.0	1.5	1.5	2.1
Space requirement	CxG	mm	110 x 164	157 x 237	155 x 280	155 x 237	156 x 275	155 x 237	156 x 275	156 x 275
Stand height	K	mm	355	450	570	450	570	450	570	570
Weight		kg	ca. 11.5	ca. 25	ca. 31	ca. 28	ca. 34	ca. 31	ca. 37	ca. 40

Extras (siehe Seite 8)	Please specify when ordering.									
Table bore 12 ^{H7}	TB	TB	TB	TB	TB	TB	TB	TB	TB	TB

* Specify the stroke length when ordering.

Valve and service unit only included with controller. Design may vary.

The accessories

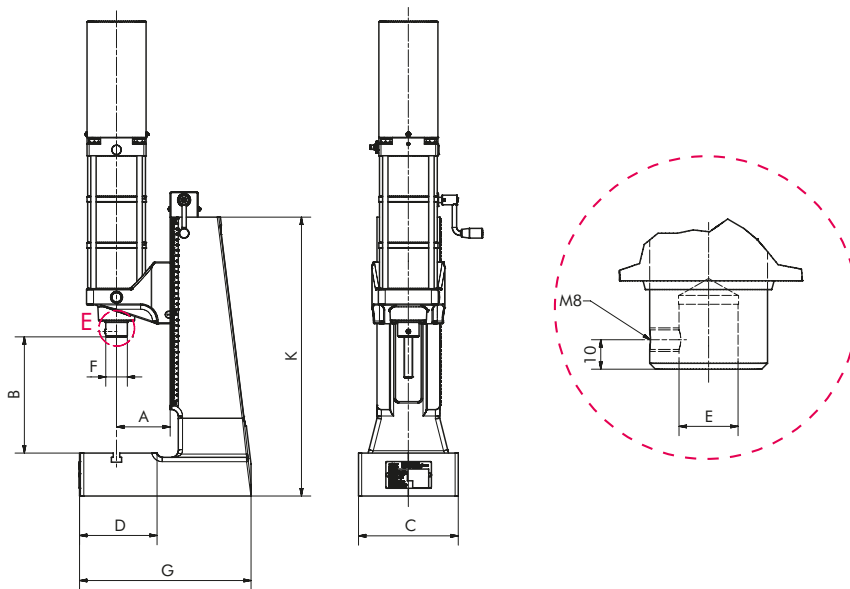
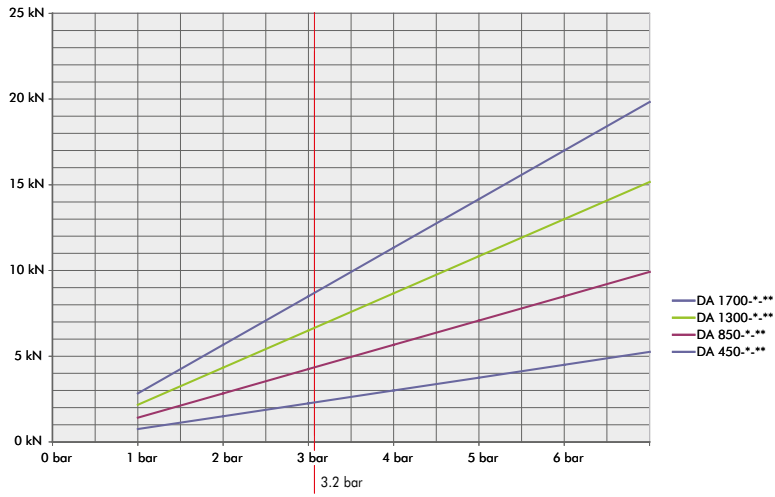
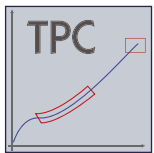
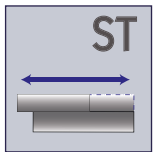
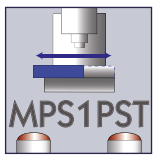
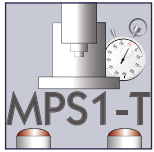
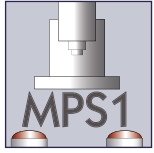

For details of fine stroke adjustment see page 37